

Myristic acid as phase change material (PCM) for increased productivity of solar distillation plant

CATURWATI NI KETUT* , YUSUF YUSVARDI and KOMARA FAJAR MUHAMAD

Mechanical Engineering Department Universitas Sultan Ageng Tirtayasa, Jl. Jend.Sudirman km.3, Cilegon 42435, Indonesia

Received: November 29, 2019 • Accepted: March 18, 2020

International Review of Applied Sciences and Engineering

DOI:
10.1556/1848.2020.00077
© 2020 The Authors

ORIGINAL RESEARCH PAPER



ABSTRACT

The availability of freshwater is increasingly becoming an international concern because of the increase in population and the diminishing forest area as a source of water, leading to a freshwater crisis. The coastal and swamp areas abound in water, but humans cannot consume it due to the quality. One effort that can be done in overcoming this problem is by treating existing raw water with solar distillation methods. However, the main obstacle faced in this method is the intensity of sunlight that is not stable throughout the day so that the productivity of distilled water is disrupted. Using the appropriate phase change material (PCM) is expected to make the distillation process smoother and increase the production of pure water. In this study, myristic acid was used as PCM in double slope solar distillation system. Through observation, it was obtained that the average water temperature in the basin equaled to 42.5 °C while the melting point of the myristic acid was 58 °C. This shows that the use of myristic acid as an energy storage through phase change process does not occur. Therefore, the use of myristic acid as PCM for increasing the productivity of solar distillation in these experiments is not effective because the melting point of PCM is higher than water temperature in the basin. Therefore, material with a phase change temperature below 42.5 °C is more appropriate to use in these conditions.

KEYWORDS

solar distillation, PCM, myristic acid, thermal storage

1. INTRODUCTION

The main international problem today is the insufficiency of freshwater. The latest statistical data from the World Health Organization (WHO) shows that more than two billion people around the world have difficulty getting freshwater. It is estimated that by 2025, more than 4 billion people will find it difficult to get freshwater. In some environments such as coastal and swamp areas water is in abundance, but it is very difficult to obtain freshwater. For areas like this, water treatment technology is needed to make non-consumable water into clean water, and solar distillation is the most efficient method for providing freshwater from brackish and/or seawater.

Solar water distiller uses the heat of sun radiation to increase the water temperature in the basin until some of the water evaporates, this makes the air inside the equipment have high moisture. When air with high moisture touches the surface of the cover with a lower temperature, the moisture in the air will condense immediately, so that pure water (H₂O) will be obtained. The salt, minerals and the other impurities are left behind in the basin.

Of all the renewable energy resources, solar energy has the highest potential in Indonesia because Indonesia is located around the equator so it gets abundant sunlight all the time. Therefore, the solar distillation seems not only logical but also in some cases essential. Indonesia as an archipelago country has easier access to seawater or swamp water, and with abundant solar energy potential, it is reasonable to implement solar distillation systems.

Naturally, the solar energy is not available all day with a fixed amount, as it is available only during the daytime. Therefore, it is an obstacle to reliance on solar energy as a primary source of energy.

*Corresponding author.
E-mail: n4wati@untirta.ac.id

During the daytime, the solar energy supply is abundant and varied, but at night it is zero. So it takes a technique to store solar energy during the day and release it at night. It is impossible to store solar radiation, but by converting the solar energy into a latent heat in changes in certain material phases, the energy can be stored to use when solar radiation decreases or when it is not available at all. By using the latent heat of the material, thermal energy can be saved. During the material phase change from solid to liquid or from liquid to gases, some heated energy will be absorbed for storage and vice versa.

Two main components are required to utilize solar energy: collector units and storage units. Both components are collector units and storage units. The collector collects energy from the solar radiation that falls on it and converts the energy into other forms of energy, while the storage unit is required to store the solar radiation energy at a high radiation intensity and immediately release it when the intensity of solar radiation is low.

The solar distillation equipment collects the solar radiation energy received and passes it through the transparent glass mounted on an airtight basin to heat the raw water in the basin. The incoming energy heats up the raw water in the basin until evaporation occurs, the moisture air above the basin surface increases. When the moist air hits the cooler glass cover, the vapors will condense and move accordingly to the gravity on the inner glass surface. Furthermore, the collector holds the fresh water produced.

To maintain the balance of the distillation process, the use of phase changes the material as an energy storage is very appropriate. The energy storage mechanism occurs nearly the isothermal with high storage density [1–3]. The phase change of the temperature of each material is different, as well as the values of the latent heat and thermal conductivity. For phase-change material application selection, the phase change of the temperature is of utmost importance.

The addition of the Sodium Thiosulfate Penta-Hydrate as phase change material (PCM) in the solar desalination system with solar collector increases the fresh water productivity up to 23%. In this experiment, the maximum temperature of water in the basin reached 65.2 °C, while the melting point of Sodium Thiosulfate Penta-Hydrate was 48.5 °C [4].

Thermal energy storage by involving the heat of latent fusion has some interesting features because of its high

Table 1. Properties requirement of PCM

Properties	Requirements
Thermal	Suitable Phase Change Temperature. High Latent heat.
Physical	High thermal conductivity. Phase equilibrium. High density. Small volume change.
Kinetic	No super cooling. Sufficient crystallization rate.
Chemical	No fire hazard. No toxicity. High chemical stability. Compatibility
Economic	Low cost. Abundant. Available

storage density and isothermal properties of the storage process at melting temperatures. Phase changes from solids to liquids or vice versa are preferred because the temperature and operational pressure are lower than changes in liquid to gas or solid to the gas phase [5–6]. Table 1 presents the requirement of the phase change materials properties.

The aim of this paper is to investigate the influence of myristic acid as PCM at a single basin solar distillation with double slope type that was applied in the Cilegon area in May 2019.

2. EXPERIMENTAL SETUP

Solar distillation plant used in this study is a system with double slope basin stills. This system is suitable to use in Indonesian region, because Indonesia has a climate like summer climatic conditions. For summer climatic conditions, the systems with double slope basin stills provide better performance than the single basin stills, vice versa, systems with single slope are better for cold climatic conditions [7].

Fig. 1 shows the double slope basin stills equipped with temperature measuring devices. The dimensions of the

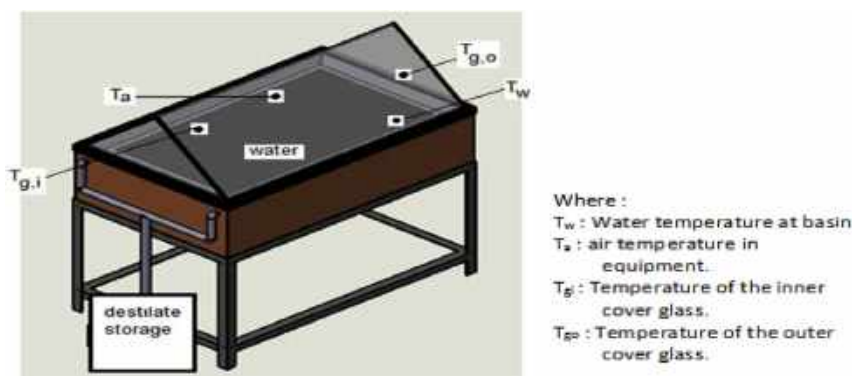

Fig. 1. The double slope basin systems with temperature measuring devices

basin used are 108 cm long, 60 cm wide and 30 cm deep with the glass wool coated on the outer side as insulation. At the top of the basin there are two transparent glasses with a 45° degree slope angle installed. The thickness of the transparent glass used is 3 mm, which enables the sunlight to penetrate through the water in the basin. In this experiment, the depth of the raw water material in the basin was 10 cm, while the data collection was carried out every hour from 8:00 to 17:00, while the distillate water collected measured 24 hours from 08.00 to 08.00 the next day. Thermocouples are fixed to take the temperature of water in the basin, air temperature above the basin, inner and outer glass temperature, and the environmental temperature.

Specification of materials in the basin:

1. Raw water:
 - Dirty water coming from the river
 - Quantity: 63.6 liters
2. PCM which is inserted into a plastic pipe:
 - Material: myristic acid, $\text{CH}_3(\text{CH}_2)_{12}\text{COOH}$
 - Mass: 4 kg
 - Melting point: 58 °C
 - Latent heat: 199 kJ/kg.



Fig. 2. Solar distillation system without PCM and with PCM

3. METHODOLOGY

The experiment is carried out at the same time between using PCM and without PCM with two similar equipments and at the same location. The research location in Cilegon at the global position of 5.99 S; 106.03E, with a tropical (wet, hot and humid) climate the entire year. Fig. 2 shows the two solar distillation systems used in the test simultaneously.

The measurement data on May 15, 2019 is shown in Table 2. The amount of distilled water in one day is determined from the measurement results from 08.00 to 08.00 the next day, 610 mL fresh water production without PCM and 450 mL fresh water with PCM. Thus, the production of distillation at night was 300 mL without PCM and 330 mL with PCM.

The experiment repeated in 5 days repetitions.

4. RESULT AND DISCUSSION

4.1. Intensity of solar radiation

Measurement of the intensity of solar radiation using a lux meter. Fig. 3 shows the average of solar radiation intensity

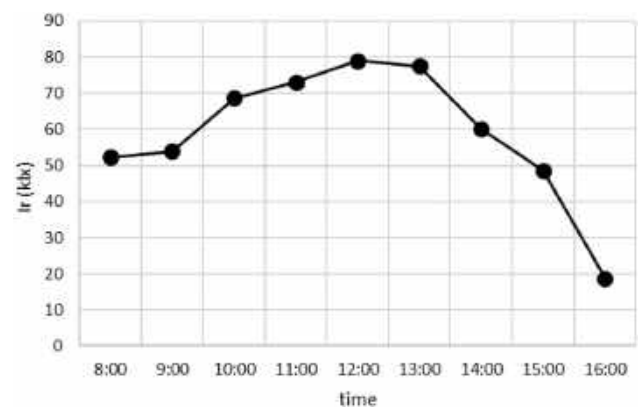
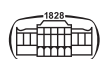

Fig. 3. Average distribution of solar radiation intensity throughout The day for 5 days of observation

Table 2. Experimental data on May 15, 2019

Time	Te (°C)	Ir (klx)	Tw (°C)		Ta (°C)		Vol (mL)	
			no PCM	PCM	no PCM	PCM	no PCM	PCM
8:00	33	73	35	31.2	40.3	42.4		
9:00	34	84.8	38	33.9	46.1	46.4		
10:00	35	60.1	34.3	36.5	45.7	48.3		
11:00	34.7	27.8	38.6	39.5	43.9	44.7		
12:00	34	33.8	41.1	40.8	41.1	40.5		
13:00	33	16.3	42.2	41.4	41.2	41.1	50	
14:00	34	19	42.7	41.6	42.2	42.5	80	30
15:00	32	14.4	41.6	41.2	40.7	40.2	100	50
16:00	31	8.2	39.9	40.9	38.7	38.7	150	100
17:00	29	0	39.8	30.7	37.3	30.7	310	120
8:00			May 16, 2019				610	450

Te is the environmental temperature, Ir is the solar radiation intensity, Tw is the water temperature in the basin, Ta is the air temperature in stiller, Vol is the amount of distillate produced.



for 5 days measurement. The maximum radiation intensity value generally occurs around 10.00–14.00; the average value at these times is 71.672 klx. While the average value of the intensity of solar radiation from 08.00 to 16.00 is 59.108 klx or equivalent 46.696 kW/m².

The maximum value of measuring the intensity of solar radiation during observation is equal to 99 klx at 11 pm on May 18, 2019. On the third day of observation, the environmental conditions were cloudy, so the intensity of solar radiation dropped dramatically where at 11 am, the value of the intensity of solar radiation was less than 30 klx.

4.2. Temperature Water in the Basin

Fig. 4 presents the average water temperature in the basin during observation. The temperature of water with the addition of myristic acid as PCM appears to be lower than the temperature of water without PCM. The maximum water temperature for systems without PCM is 46.86 °C at 15.00, while for systems with PCM at the same time obtained the maximum water temperature is 44.16 °C.

Solar radiation energy is received by water to increase water temperature in basin without PCM, while for the systems with PCM the solar radiation energy received by the

system to increase water temperature and PCM temperature. Thus, the increase in the water temperature in a basin without PCM is higher compared to systems with added myristic acid.

4.3. Distillation productivity

Fig. 5 shows distillation production during the day for systems without PCM and with PCM. The system starts to produce distilled water when the intensity of solar radiation begins to decrease. In this research, distillation starts at 13.00. Distillation produced during the day (08.00–16.00) for systems with the addition of Myristic-acid is less than for systems without PCM.

Furthermore, distillation production occurs throughout the night. Fig. 6 shows the comparison of day and night distillation production for the second day to the fifth day. On the first day, distilled water production during the night is not recorded.

Distillation production at night is greater than during the daytime. For the systems without myristic acid, the increase in distillation production at night reaches an average of 217% of the production during the day, while for the systems with myristic acid, an increase in the average production at

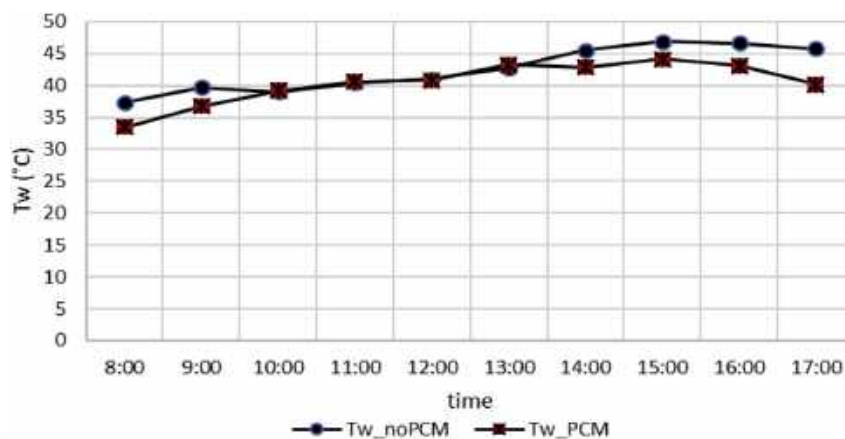

Fig. 4. Average temperature distribution of water in the basin

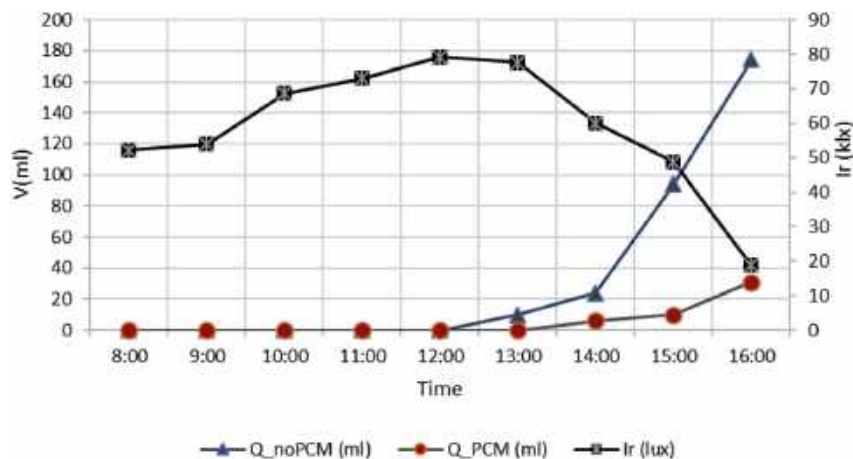

Fig. 5. Distillate production during the day

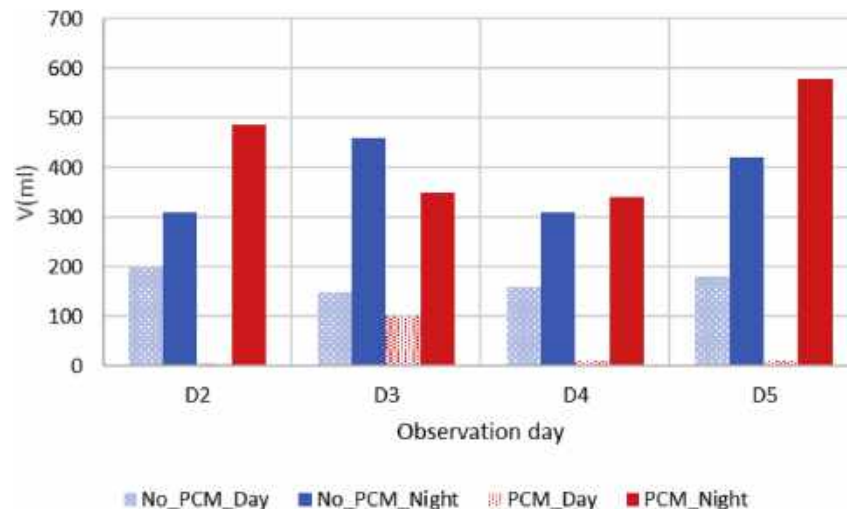

Fig. 6. Distillation production during day and night for system with PCM and without PCM

night reaches 1,404% of the production during the day. Thus, during the day, the PCM material absorbs heat energy from solar radiation that enters the system and at night when the temperature of the water in the basin decreases, the stored heat released into the water [8-11]. Therefore, the rate of evaporation of water in the systems with PCM is higher than the rate of evaporation in systems without PCM. Furthermore, the condensation productivity in the systems with PCM is higher than in the systems without PCM at night.

Cumulatively the use of myristic acid as a PCM material used as a storage of thermal energy is unsatisfactory because the distillation produced for systems with the addition of myristic acid is lower than for systems without myristic acid. This is because the temperature of the water in the basin does not reach the melting temperature of myristic acid. Myristic acid added to the system only helps to store the heat during the day and releases it at night without undergoing phase changes.

5. CONCLUSION

The use of the solar distillation plant with double slope system installed in the Cilegon area, with 10 mm depth of water shows the maximum water temperature in the basin reached 51.2 °C and the average temperature in the day is 42.5 °C. This value is lower than the melting point of myristic acid, 58 °C. So the heat storage during the day by myristic acid does not go through a phase-change process, thus the thermal storage capacity is small. Therefore, the application of myristic acid as storage energy by phase-change material in solar distillation system becomes ineffective. The addition of myristic acid into the basin makes the water temperature lower than the water without myristic acid during the day. As a result, the productivity of condensed water becomes low. Conversely, at night the heat stored in myristic acid is released into the water so the production of distilled water is higher than in the system

without myristic acid. Therefore, the addition of myristic acid in the system becomes an obstacle during the day, but during the night, it is quite helpful in increasing the production of distillates.

Because the average temperature of water in the basin reaches 42.5 °C, the selection of the recommended PCM material should have a melting temperature below that temperature.

ACKNOWLEDGMENTS

This research was supported by DRPM, 2019. Ditjen Penguatan Risbang Funding, Engineering Faculty of Universitas Sultan Ageng Tirtayasa.

REFERENCES

- [1] A. Om Nayak, M. Gowtham, R. Vinod, and G. Ramkumar, "Analysis of PCM material in thermal energy storage system," *Int. J. Environ. Sci. Dev.*, vol. 2, no. 6, 2011.
- [2] F. Fatih demirbas, "Thermal energy storage and phase change materials: an overview," *Energy Sources B*, vol. 1, pp. 85–95, 2006.
- [3] N. A. M. Amin, M. Belusko, and F. Bruno, "Optimization of a phase change thermal storage system," *World Acad. Sci. Eng. Technol.*, vol. 56, 2009.
- [4] M. Al-harashsheh, M. Abu-Arabi, H. Mousa, et al. "Solar desalination using solar stii enhanced by external solar collector and PCM," *Appl. Thermal Eng.*, vol. 128, pp. 1030–40, 2018.
- [5] A. Mani and S. Rangarajan, *Solar Radiation Over India*, New Delhi, Allied Publishers Private Limited, 1982.
- [6] A. Sharma, V. V. Tyagi, C. R. Chen, and D. Buddhi, "Review on thermal energy storage with phase change materials and applications," *Renew. Sust. Energ. Rev.*, vol. 13, pp. 318–45, 2009.
- [7] M. Malik, G. Tiwari, A. Kumar, and M. Sodha, *Solar Distillation: A Practical Study of a Wide Range of Stills and their Optimum Design Construction and Performance*, Pergamon Press, 1996.

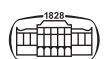

- [8] A. Sharma and C. R. Chen, "Solar water heating system with phase change materials," *Int. Rev. Chem. Eng.*, vol. 1, no. 4, July 2009.
- [9] A. Patel and S. Namjoshi, "Phase change material based solar water heater," *Int. J. Eng. Sci. Inv.*, vol. 5, no. 8, August 2016.
- [10] S. Naga Sarada, B. H. Bindu, R. Sri, et al. "Solar water distillation using two different phase change materials," *Appl. Mech. Mater.*, vols. 592–594, pp. 2409–15, 2014.
- [11] D. C. Kantesh, "Design of solar still using Phase changing material as a storage medium," *Int. J. Sci. Eng. Res.*, vol. 3, no. 12, December 2012.





Largest PCB CAD Library

More models than Instagram. Find your parts now.

Ultra Librarian

[VISIT SITE](#)

International Review of Applied Sciences and Engineering

Country [Hungary](#) - [IIII](#) [SJR Ranking of Hungary](#)

Subject Area and Category [Computer Science](#)
[Information Systems](#)

[Decision Sciences](#)
[Management Science and Operations Research](#)

[Engineering](#)
[Engineering \(miscellaneous\)](#)

[Environmental Science](#)
[Environmental Engineering](#)

[Materials Science](#)
[Materials Science \(miscellaneous\)](#)

Publisher [Akademiai Kiado](#)

Publication type Journals

ISSN 20620810, 20634269

Coverage 2017-2019

Scope International Review of Applied Sciences and Engineering is a peer reviewed journal. It offers a comprehensive range of articles on all aspects of engineering and applied sciences. It provides an international and interdisciplinary platform for the exchange of ideas between engineers, researchers and scholars within the academy and industry. It covers a wide range of application areas including architecture, building services and energetics, civil engineering, electrical engineering and mechatronics, environmental engineering, mechanical engineering, material sciences, applied informatics and management sciences. The aim of the Journal is to provide a location for reporting original research results having international focus with multidisciplinary content. The published papers provide solely new basic information for designers, scholars and developers working in the mentioned fields. The papers reflect the broad categories of interest in: optimisation, simulation, modelling, control techniques, monitoring, and development of new analysis methods, equipment and system conception.



[Homepage](#)

[How to publish in this journal](#)

[Contact](#)

4

H Index

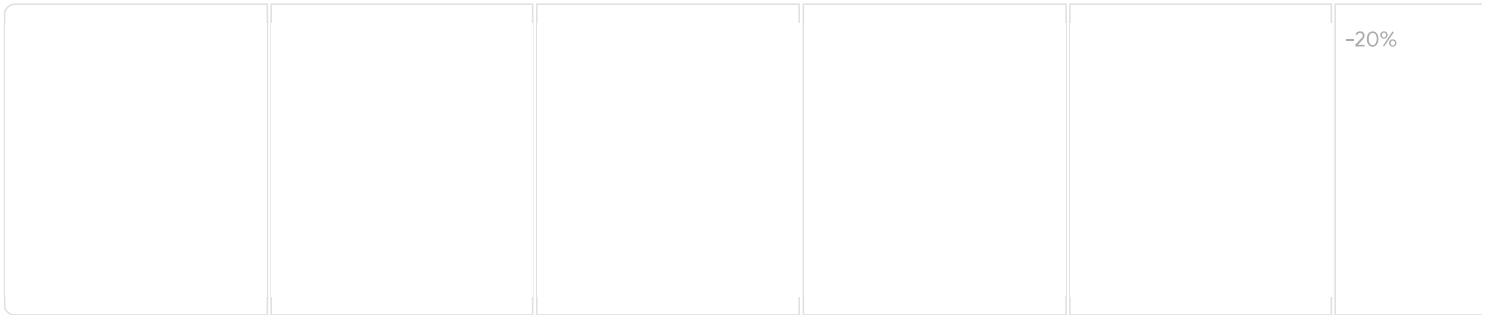

-20%

Perkakas & ATK Terlengkap
Toko Online monotaro.id

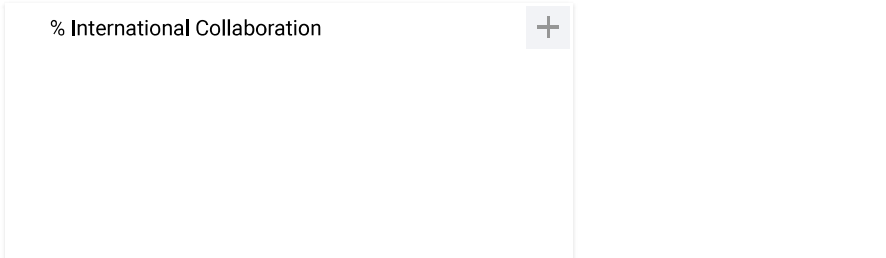
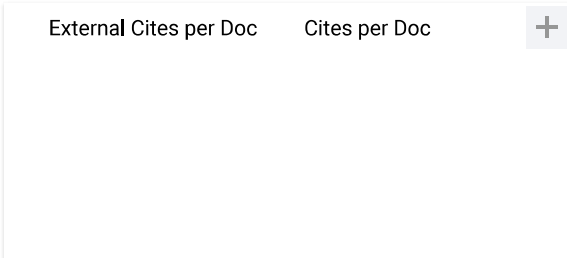
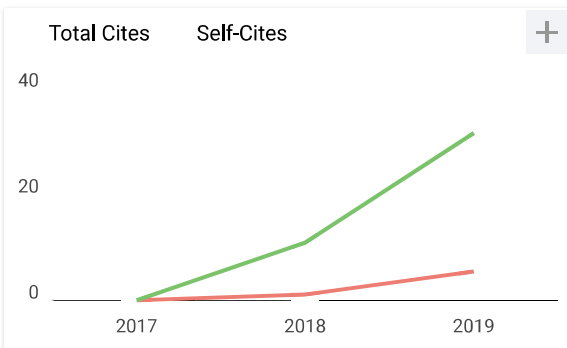
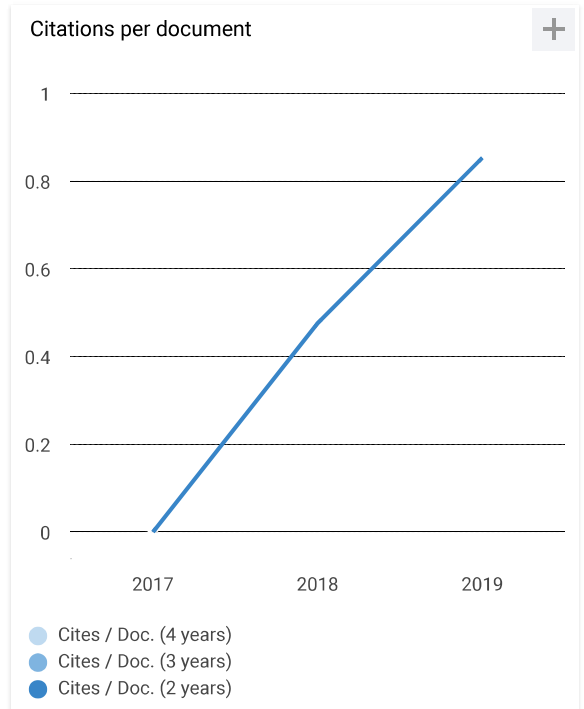
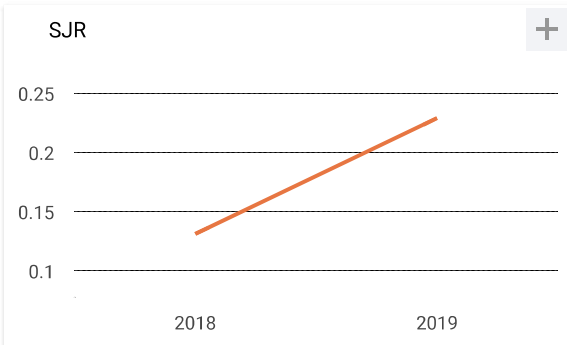
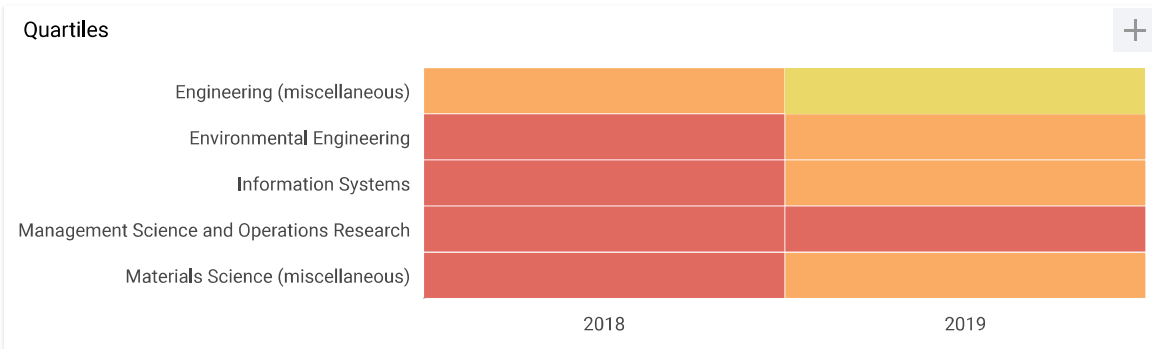

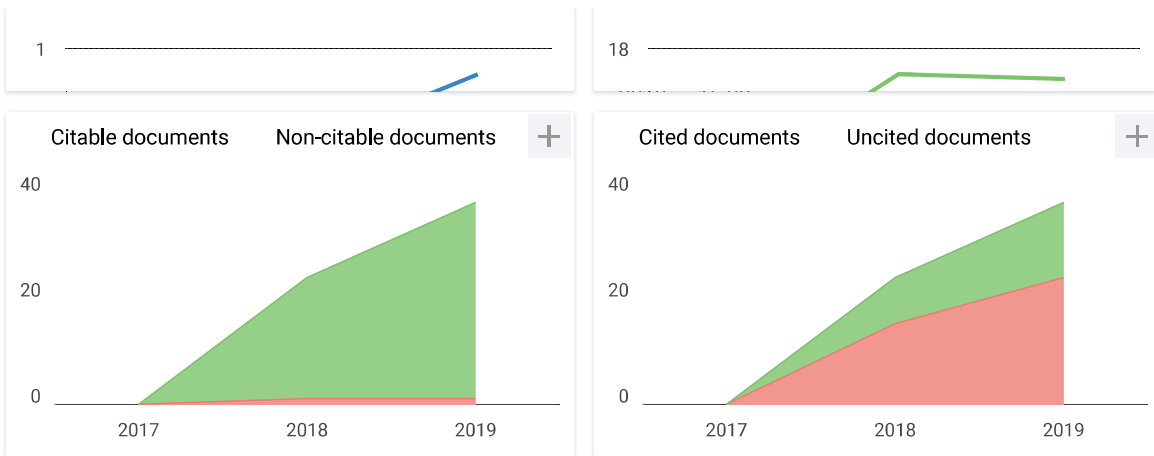

International Review of Applied Sciences and...

← Show this widget in your own website

Just copy the code below and paste within your html code:

```
<a href="https://www.scimaç
```

					-20%
--	--	--	--	--	------

Toko Online untuk Perusahaan
monotaro.id

Metrics based on Scopus® data as of April 2020

C **caturwati** 4 weeks ago

what about the status of the journal in 2020 and beyond? Is the Scopus index for the IRASE journal continued?

reply



Melanie Ortiz 4 weeks ago

SCImago Team